

Versione ad ASSE NUDO *BARESHAFT construction*

Esecuzione /R
 Construction /R

Esecuzione /C Construction /C

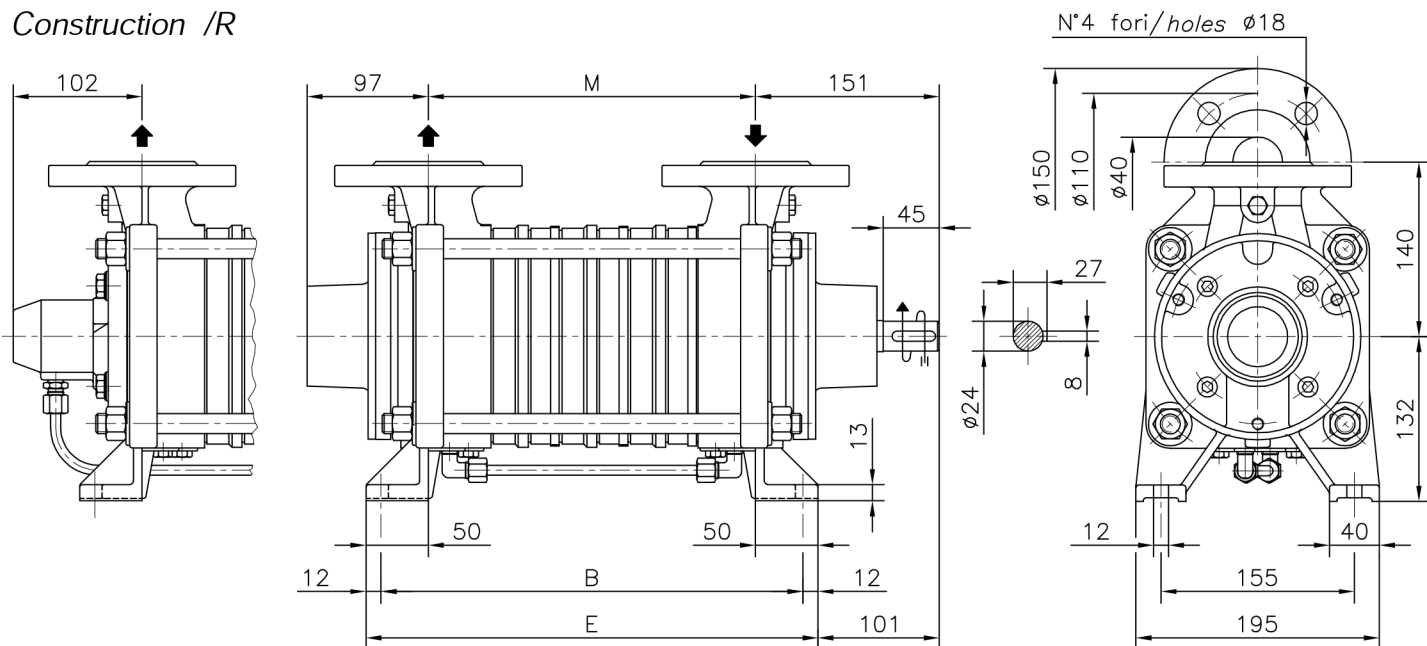

POMPA TIPO <i>Pump type</i>	Versione ad ASSE NUDO			<i>BARESHAFT construction</i>		
	DIMENSIONI <i>Dimensions</i>			/R - /C	/R/T	/C/T
	M	B	E	Peso <i>Weight</i>	Peso <i>Weight</i>	Peso <i>Weight</i>
TBH 401	152	228	252	30	38	46
TBH 402	207	283	307	35	43	51
TBH 403	262	338	362	40	48	56
TBH 404	317	393	417	45	53	61
TBH 405	372	448	472	50	58	66
TBH 406	427	503	527	55	63	71
TBH 407	482	558	582	60	68	76
TBH 408	537	613	637	65	73	81

FLANGE:
 Dimensioni secondo
 UNI 2223-2229 PN40

FLANGES:
 Dimensions to
 UNI 2223-2229 NP40 standards

Disegno schematico. Dimensioni in mm con tolleranze secondo EN 735-1995. Pesi indicativi in Kg, riferiti a pompe in ghisa escluso motore, non impegnativi.

Schematic drawing. Dimensions in mm with tolerances to EN 735-1995 standards. Weights in Kgs, referred to pumps in cast iron without motor, not certified.

Esecuzione /R/T
 Construction /R/T

Esecuzione /C/T Construction /C/T

