

Versione ad ASSE NUDO *BARESHAFT construction*

Esecuzione /R
 Construction /R

Esecuzione /C Construction /C

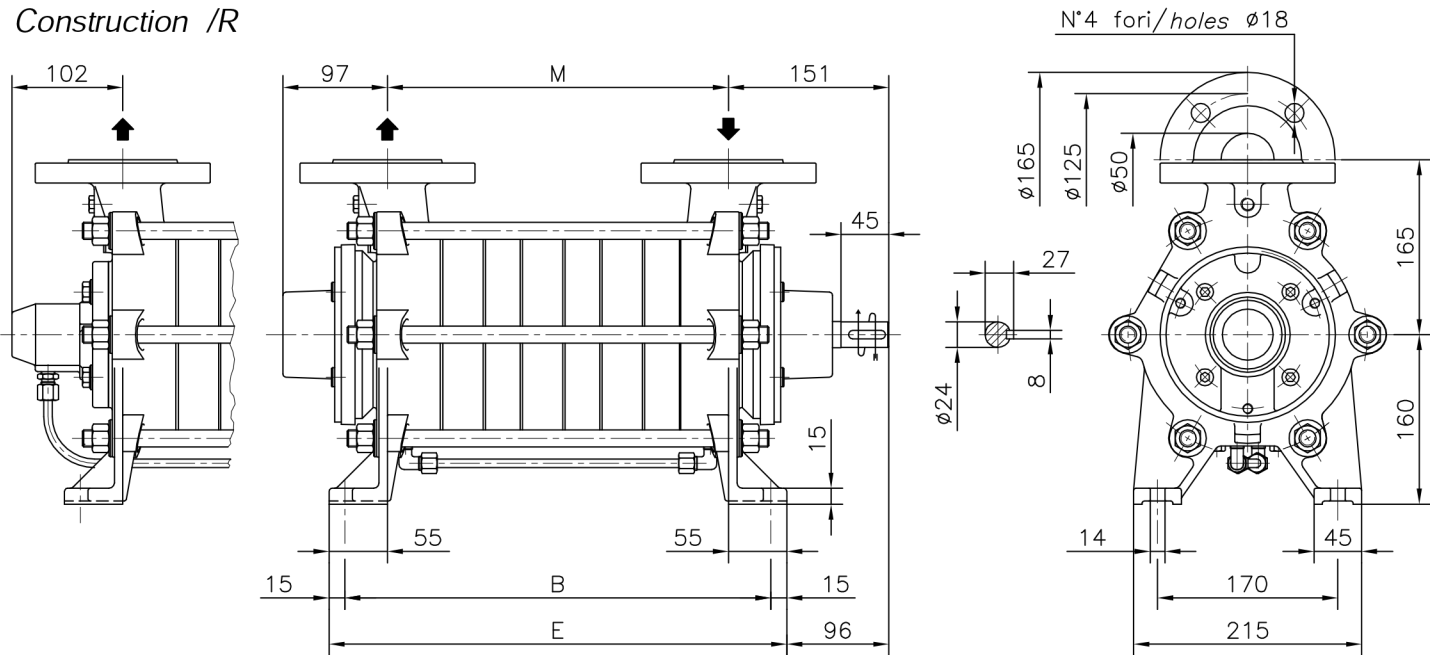

POMPA TIPO <i>Pump type</i>	Versione ad ASSE NUDO			<i>BARESHAFT construction</i>		
	DIMENSIONI <i>Dimensions</i>			/R - /C	/R/T	/C/T
	M	B	E	Peso <i>Weight</i>	Peso <i>Weight</i>	Peso <i>Weight</i>
TBH 501	171	251	281	39	47	55
TBH 502	246	326	356	49	57	65
TBH 503	321	401	431	59	67	75
TBH 504	396	476	506	69	77	85
TBH 505	471	551	581	79	87	95
TBH 506	546	626	656	89	97	105
TBH 507	621	701	731	99	107	115
TBH 508	696	776	806	109	117	125

FLANGE:
 Dimensioni secondo
 UNI 2223-2229 PN40

FLANGES:
 Dimensions to
 UNI 2223-2229 NP40 standards

Disegno schematico. Dimensioni
 in mm con tolleranze secondo
 EN 735-1995. Pesì indicativi in Kg,
 riferiti a pompe in ghisa escluso
 motore, non impegnativi.

Schematic drawing. Dimensions in
 mm with tolerances to
 EN 735-1995 standards. Weights in
 Kgs, referred to pumps in cast iron
 without motor, not certified.

Esecuzione /R/T
 Construction /R/T

Esecuzione /C/T Construction /C/T

